

FESTA[®]

PROFESSIONAL  TOOLS

20
23

NOVINKY
NEW
ITEMS



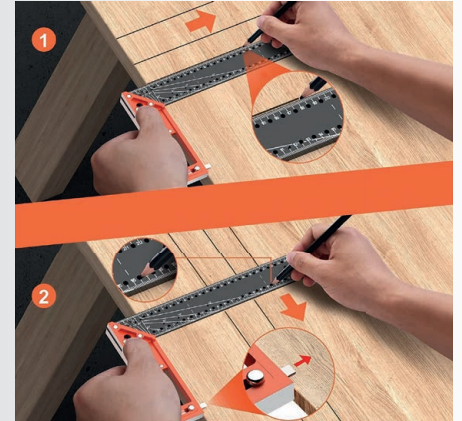
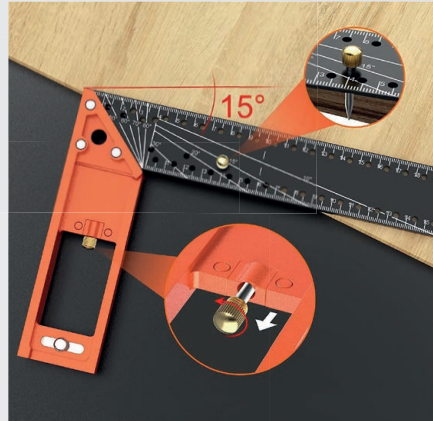
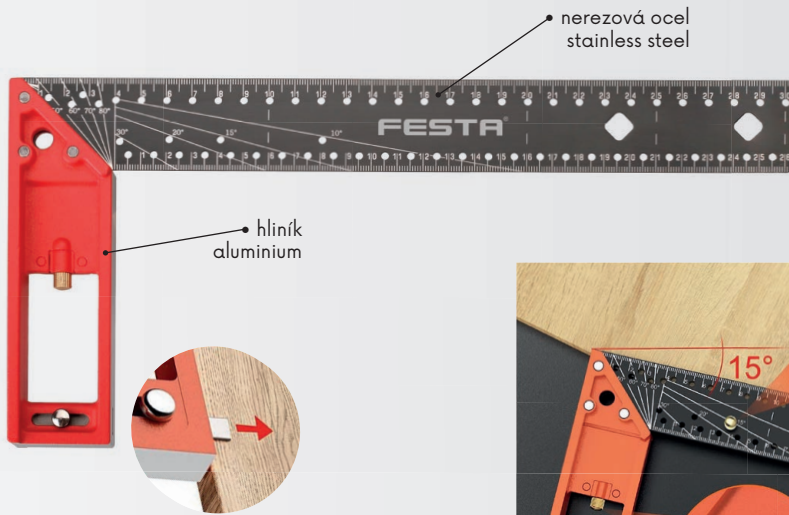

FESTA
ÚHELNÍK TRUHLÁŘSKÝ
SQUARE

INOX ALU

Č.p. No.	Specifikace Specification
14415	300 mm
14417	400 mm

6
6



VÍCEÚČELOVÉ SKLÁDACÍ PRAVÍTKO
MULTIPURPOSE FOLDING RULER

Č.p. No.	Specifikace Specification
14077	

1

FESTA
ODIZOLOVÁČ KABELŮ
UNIVERSAL STRIPPING TOOL

AWG	mm ²
10	6,0
12	4,0
14	2,5
16	1,5
18	1,0
20	0,5

koaxiální kabel RG6/59 | coaxial cable RG6/59
nízkonapěťový kabel Ø 8 - 13 mm | low voltage cable Ø 8 - 13 mm



Č.p. No.	Specifikace Specification
16202	125 mm

10



FESTA

LASER ZELENÝ KŘÍŽOVÝ 3D CROSS-LINE GREEN LASER 3D

- 1x horizontální rovina + 2x vertikální rovina (zelený paprsek)
- samonivelační rozsah $\pm 4^\circ$
- přesnost: 0,2 mm/m
- ve vnitřních prostorech 30 m, s laserovým přijímačem až 50 m
- pulzní režim – doporučené příslušenství přijímač 26209
- dodáváno s: přepravní kufr, 4 x AA alkalické baterie, laserový terč, brýle, Li-ion baterie 2600 mAh, profesionální držák, nabíječka, držák Li-ion baterie

- 1x horizontal plane+2x vertical plane(green beam)
- self-levelling range $\pm 4^\circ$
- accuracy 0,2 mm/m
- indoor: 30 m, outdoor with detector 50 m
- pulse mode – recommended accessory receiver 26209
- inclusive: carrying case, 4xAA alkaline batteries, laser target, goggles, 2600 mAh Li-ion battery, professional bracket, charger, cradle of Li-ion battery



Č.p. | No. Specifikace | Specification
26204 zelený | green

02|2023



1



FESTA

LASER ZELENÝ KŘÍŽOVÝ CROSS-LINE GREEN LASER

- 1x horizontální rovina + 1x vertikální rovina (zelený paprsek) | samonivelační rozsah $\pm 3^\circ$
- přesnost: 0,2 mm/m
- ve vnitřních prostorech 20 m, s laserovým přijímačem až 50 m
- pulzní režim – doporučené příslušenství přijímač 26209
- dodáváno s: přepravní pouzdro, 2 x AA alkalické baterie, držák

- 1x horizontal plane+1x vertical plane(green beam)
- self-levelling range $\pm 3^\circ$
- accuracy 0,2 mm/m
- indoor: 20 m, outdoor with detector 50 m
- pulse mode – recommended accessory receiver 26209
- inclusive: carrying case, 2xAA alkaline batteries, bracket



Č.p. | No. Specifikace | Specification
26201 zelený | green

02|2023



1



FESTA

LASEROVÝ PŘIJÍMAČ LASER RECEIVER

- pro lasery s pulsním režimem k prodloužení dosahu až 50 m
- dodáváno s: 9 V baterie, držák
- pro 26201, 26204

- for use with pulsed laser devices to extend the range then 50 m
- inclusive: 9 V battery, bracket
- for 26201, 26204



Č.p. / No. Specifikace / Specification
26209 dosah / range: 50 m

02|2023
1

FESTA

DÁLKOMĚŘ RANGE-FINDER

- rozsah měření 0,05 - 50 m
- přesnost měření ± 2 mm, jednotka měření mm/in/ft
- kontinuální měření, měření plochy, měření objemu, výpočet délky třetí strany dle pythagorovi věty, LCD FSTN, sčítání/odčítání, max./min. měření
- maximální úložisko na 100 hodnot, čtyřřadý displej LCD FSTNS s podsvícením,
- vlnová délka laseru 630 - 670 nm, pracovní teplota 0 - 40°C
- rozměry 112 x 50 x 25 mm, hmotnost 90 g
- dodáváno s: přepravní pouzdro, 2xAAA alkalické baterie

- measuring range 0,05 - 50 m
- measuring accuracy ± 2 mm, measuring unit mm/in/ft
- continuous measurement, area measurement, volume measurement, triangle leg measurement, LCD FSTN, addition/subtraction, max./min. measurement, max storage 100 units, backlight, laser class 630-670 nm class 2
- operating temperature 0 - 40°C
- size 112 x 50 x 25 mm, weight 90 g
- inclusive: carrying case, 2xAAA alkaline batteries



Č.p. / No. Specifikace / Specification
26211



02|2023
1

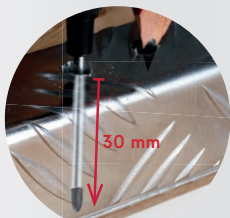

FESTA

**ZNAČKOVAČ HLOUBKOVÝ,
PERMANENTNÍ
PERMANENT MARKER**



Č.p. | No. Specifikace | Specification
13246 ● černý | black

10



**ZNAČKOVAČ PERMANENTNÍ,
OBOUSTRANNÝ
TWO SIDED PERMANENT MARKER**



Č.p. | No. Specifikace | Specification
13206 ○ bílý | white

12



FESTA

**KLEŠTĚ ŠTÍPACÍ NA JEMNÉ KABELY
ELECTRONIC DIAGONAL CUTTER**

· max Ø 0,2 - 2,1 mm

CrV



Č.p. | No. Specifikace | Specification
17047 140 mm

10



FESTA

**KLEŠTĚ ŠTÍPACÍ ČELNÍ
CARPENTER PINCERS**

CrV



Č.p. | No. Specifikace | Specification
17303 250 mm

10

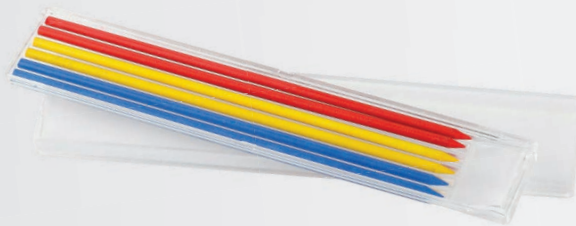

FESTA

**BAREVNÉ TUHY
DO HLOUBKOVÉHO ZNAČKOVAČE
COLORED PENCILS FOR CARPENTER PENCIL**

· pro | for 13262



Č.p. | No. Specifikace | Specification
13267 ● 2x žlutá | yellow ● 2x červená | red ● 2x modrá | blue 1



ø 0,5 mm

ø 0,5 mm

**ZNAČKOVAČ PERMANENTNÍ,
OBOUSTRANNÝ
TWO SIDED PERMANENT MARKER**



Č.p. | No. Specifikace | Specification
13207 ● červený | red
13208 ● modrý | blue

12

12



FESTA

**KLEŠTĚ ŠTÍPACÍ
BOLT CUTTER**

- měkký drát | soft wire: Ø 6 mm
- středně tvrdý drát | medium wire: Ø 5 mm
- tvrdý drát | hard wire: Ø 4 mm

CrV



Č.p. | No. Specifikace | Specification
17078 200 mm

12



FESTA

**KLEŠTĚ RABITOVÉ
RABIT PINCERS**

CrV



Č.p. | No. Specifikace | Specification
17306 250 mm

10



HLAVICE UNIVERZÁLNÍ
UNIVERSAL SOCKET HEAD



Č.p. No.	Specifikace Specification
17812	10 - 19 mm



1

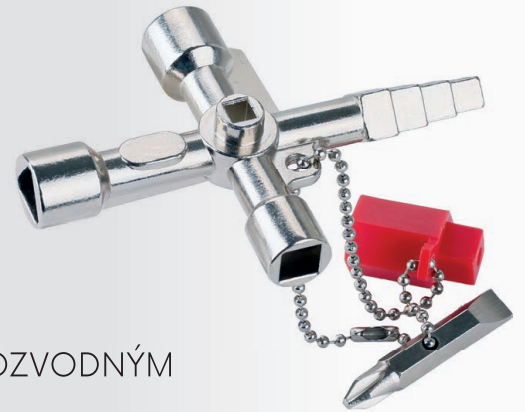

FESTA®

KLÍČ K ROZVODNÝM SKŘÍNĚM
CONTROL CABINET KEY

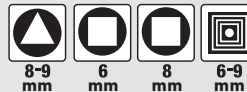

1,0 x 7 mm

PH2



Č.p. No.	Specifikace Specification
17458	

1



Stahlberg

NÁSTAVEC NA BITY
MAGNETIC BIT HOLDER



Č.p. No.	Specifikace Specification
18605	150 mm



1



FESTA®

ADAPTÉR SDS + NA BIT 1/4"
ADAPTER SDS + TO BIT 1/4"



Č.p. No.	Specifikace Specification
20743	75 mm



1



FESTA®

PALICE
Mallet

· jasanová rukojeť | ash handle

DIN 6475

Č.p. No.	Specifikace Specification
19041	1000 g
19042	1250 g
19043	1500 g
19044	2000 g



1



FESTA®

PALICE GUMOVÁ BÍLÁ
WHITE RUBBER Mallet



Č.p. No.	Specifikace Specification
19293	Ø 55 mm



6



FESTA®

PALICE
Mallet

· jasanová rukojeť | ash handle

DIN 6475

Č.p. No.	Specifikace Specification
19045	3000 g
19046	4000 g



1

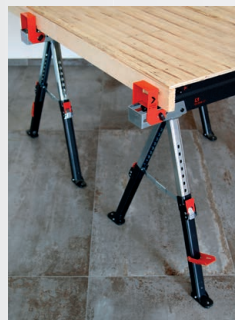

FESTA

**KOZA STAVEBNÍ
FOLDING SAW HORSE**

· maximální nosnost: 590 kg | max. load: 590 kg

Č.p. | No. Specifikace | Specification
23657



1

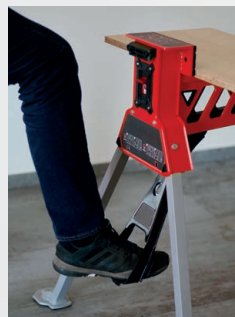

FESTA

**PŘENOSNÝ STOJANOVÝ SVĚRÁK
PORTABLE STAND VISE**

· rozsah čelistí | clamping range: 0 - 95 cm
· maximální nosnost: 250 kg | max. load: 250 kg

Č.p. | No. Specifikace | Specification
37553



02|2023



1

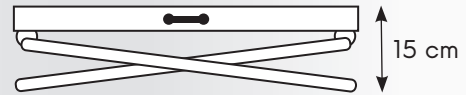

PRACOVNÍ STŮL SKLÁDACÍ
WORK TABLE

· max. 100 kg

Č.p. No.	Specifikace Specification
23655	100 x 50 x 84 cm



FESTA®

KLEŠTĚ NA PVC TRUBKY
PLIERS FOR PVC PIPE

max.
32 mm

Č.p. No.	Specifikace Specification
17037	



FESTA®

ODJEHLOVAČ
DEBURRING EXTERNAL
CHAMFER TOOL

Ø 3 – 19 mm

1/4"

Č.p. No.	Specifikace Specification
16321	



ŠTÍPACÍ TRN SDS+
WOOD SPLITTER BIT SDS+

SDS+

Č.p. No.	Specifikace Specification	
19393	Ø 32 x 132 mm	10
19374	Ø 42 x 145 mm	10



FESTA®

NÁHRADNÍ VRTÁK
PRO UNAŠEČ
NA VYKRUŽOVACÍ KORUNKY
SPARE DRILL BIT FOR HOLESAW HOLDER

· pro | for 24410, 24411

Č.p. No.	Specifikace Specification	
24412		5

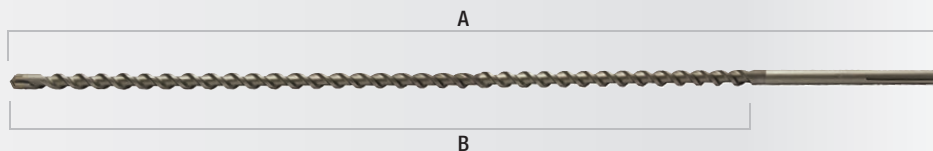

FESTA®

VRTÁK PŘÍKLEPOVÝ VIDIOVÝ SDS MAX
MASONRY DRILL SDS MAX

· čtyřbřitý vrták se zvýšenou výkonností a trvanlivostí | four drilling bit with increment of feat and lifetime

SDS
MAX



Č.p. No.	Specifikace Specification	A mm	B mm
20508	Ø 16 mm	550	395



· ukázkové video | demo video



· ukázkové video | demo video



FESTA

**KORUNKA VYKRUŽOVACÍ DIAMANTOVÁ
DIAMOND HOLESAW**

M14



- keramické obklady | ceramic tiles
- mramor | marble
- žula | granite



- použití bez chlazení vodou | no need to cool with water



Č.p. No.	Specifikace Specification	úchyt	
24670	Ø 16 mm	M14	1
24671	Ø 18 mm	M14	1
24672	Ø 22 mm	M14	1
24673	Ø 25 mm	M14	1
24674	Ø 30 mm	M14	1
24675	Ø 32 mm	M14	1
24776	Ø 40 mm	M14	1
24676	Ø 110 mm	M14	1

FESTA

**KORUNKA VYKRUŽOVACÍ DIAMANTOVÁ, SADA
DIAMOND HOLESAW - SET**

- Ø 8 mm
- Ø 10 mm
- Ø 14 mm
- Ø 22 mm
- Ø 32 mm
- Ø 40 mm
- Ø 68 mm

7x M14



- keramické obklady | ceramic tiles
- mramor | marble
- žula | granite



- použití bez chlazení vodou | no need to cool with water



Č.p. No.	Specifikace Specification	
24650		1

· Ø 2 mm - Ø 50 mm

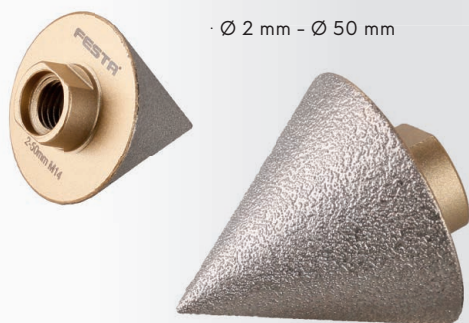

· Ø 20 mm - Ø 48 mm



FESTA

**KORUNKA VYKRUŽOVACÍ A BRUSNÁ,
DIAMANTOVÁ
DIAMOND MILLING AND GRINDING CONE**

M14



- keramické obklady | ceramic tiles
- mramor | marble
- žula | granite



- použití bez chlazení vodou | no need to cool with water



Č.p. No.	Specifikace Specification	
24778	Ø 2 - 50 mm	1

FESTA

**KORUNKA BRUSNÁ,
DIAMANTOVÁ
DIAMOND GRINDING CONE**

M14



- keramické obklady | ceramic tiles
- mramor | marble
- žula | granite



- použití bez chlazení vodou | no need to cool with water



Č.p. No.	Specifikace Specification	
24779	Ø 20 - 48 mm	1

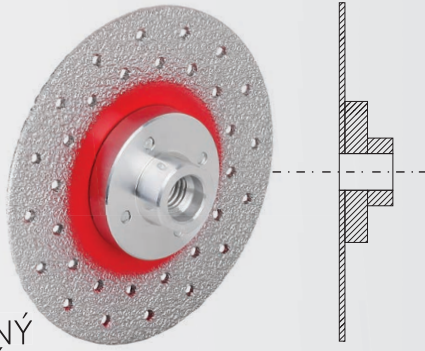

FESTA

KOTOUČ
ŘEZNÝ A BRUSNÝ
- DIAMANTOVÝ
DIAMOND CUTTING
AND GRINDING DISC

M14



· keramické obklady | ceramic tiles
· mramor | marble
· žula | granite



· použití bez chlazení vodou | no need to cool with water



Č.p. I No.	Specifikace Specification	
24655	Ø 115 mm M14	1

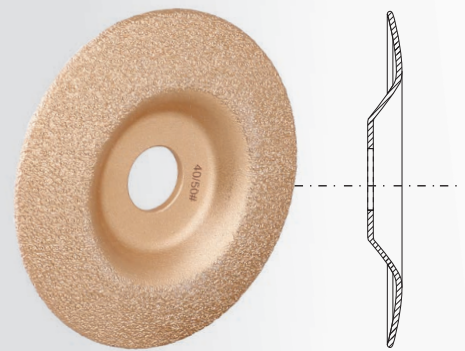

FESTA

KOTOUČ BRUSNÝ
- DIAMANTOVÝ
DIAMOND GRINDING DISC



· keramické obklady | ceramic tiles
· mramor | marble
· žula | granite



· použití bez chlazení vodou | no need to cool with water



Č.p. I No.	Specifikace Specification	
24658	Ø 115 mm Ø 22,2 mm	1



Ø 19 - 127 mm

FESTA

KORUNKA VYKRUŽOVACÍ
- NASTAVITELNÁ
ADJUSTABLE HOLESAW

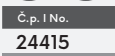

Č.p. I No.	Specifikace Specification	
24415	Ø 19 - 127 mm max. hloubka max. depth 29 mm	6

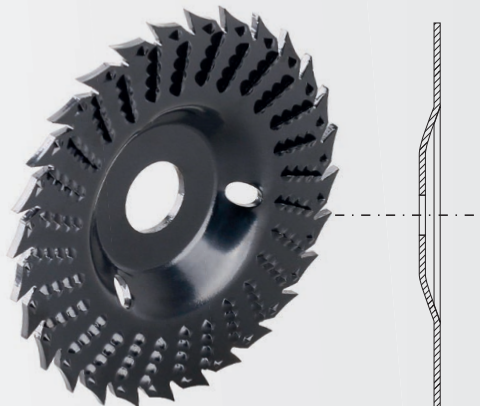

FESTA

KOTOUČ RAŠPLOVÝ - PILOVÝ
RASB AND CUT WHEEL



Č.p. I No.	Specifikace Specification	
21803	Ø 125 mm Ø 22,2 mm	1

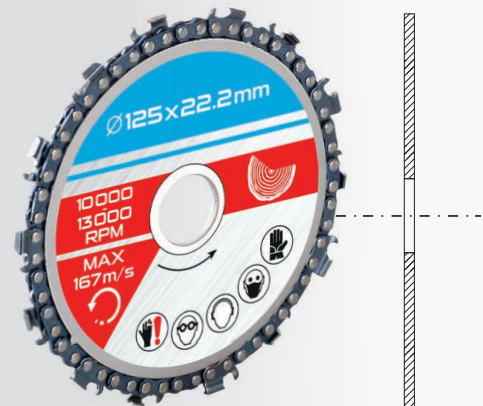

KOTOUČ ŘEZNÝ
ŘETĚZOVÝ
GRINDER CHAINSAW DISC



Č.p. I No.	Specifikace Specification	
21804	Ø 125 mm Ø 22,2 mm 14T	1

FESTA

**PLÁTEK PILOVÝ
SABRE SAW BLADE**

SK  · porobeton | aerated concrete
· porotherm | porotherm
· cihly | bricks



Č.p. No.	Specifikace Specification
24316	455 x 50 x 1,5 mm



25

FESTA

**KOTOUČ ŘEZNÝ NA KOV
CUTTING DISC FOR METAL**

10x



Č.p. No.	Specifikace Specification	
22228	Ø 115 mm Ø 22,2 mm x 1 mm	INOX
22229	Ø 125 mm Ø 22,2 mm x 1,2 mm	INOX



1
1



FESTA

**FRÉZA
DO POLYSTYRENU A VATY
POLYSTYRENE CUTTER
FOR INSULATION DOWELS**

ALU

Č.p. No.	Specifikace Specification	
24752	Ø 65 mm	1
24753	Ø 70 mm	1



**ZATEPLOVACÍ PODLOŽKA
INSULATION PAD**

· pro šrouby Ø 6 a 8 mm | for screws Ø 6 and 8 mm

50x

Č.p. No.	Specifikace Specification	
39208	Ø 68 mm	1

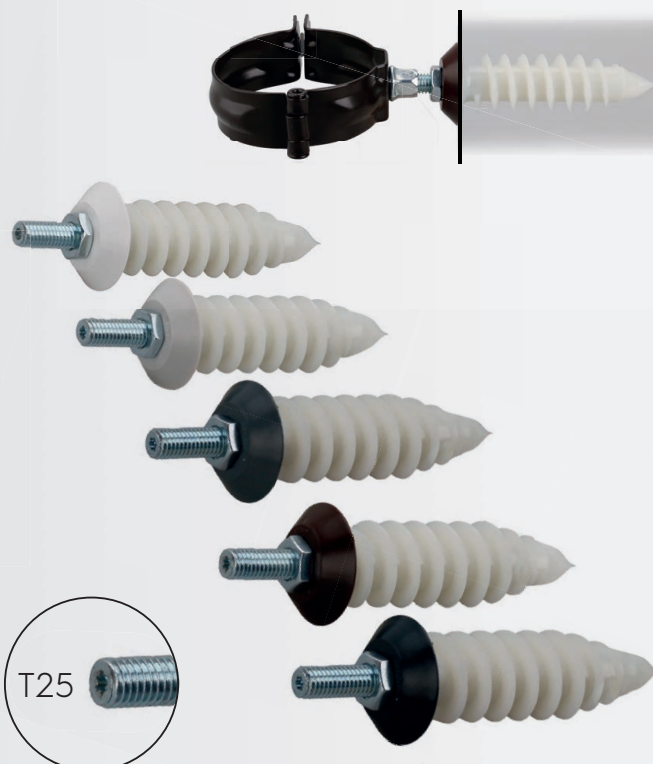

**HMOŽDINKA DO IZOLACE PRO
ŠROUBOVACÍ OBJÍMKY SVODU
DOWEL INTO THE INSULATION FOR
LEAD SCREW SLEEVES**

2x

Č.p. No.	Specifikace Specification	
39240	● bílá white M10	1
39241	● šedá grey M10	1
39242	● antracit anthracite M10	1
39243	● hnědá brown M10	1
39244	● černá black M10	1



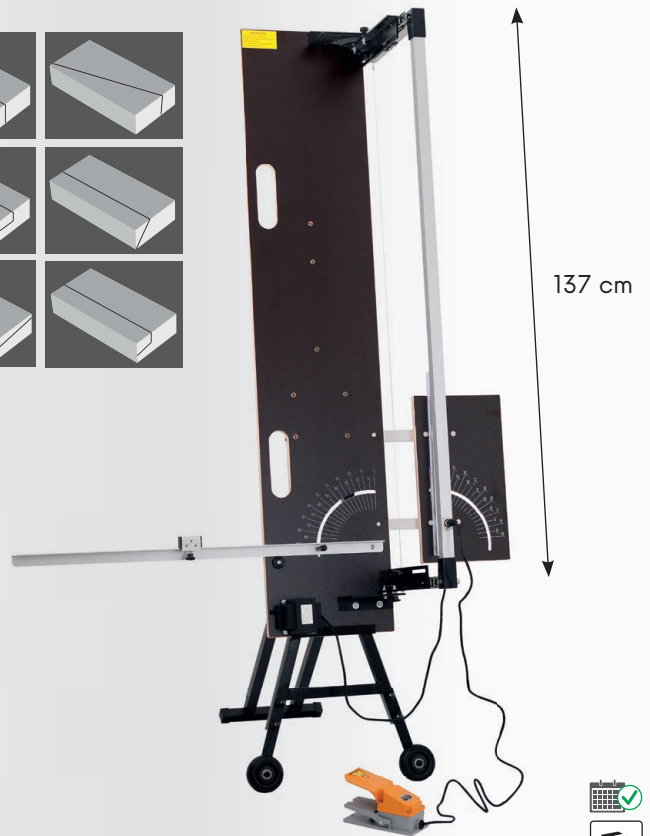
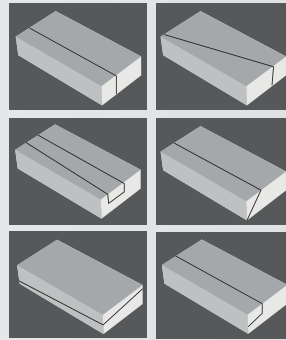

FESTA

ŘEZAČKA POLYSTYRENU
POLYSTYRENE CUTTER

- napětí/frekvence | voltage/frequency 230 V/50 Hz
- příkon | power consumption 160 W
- délka řezu | length of cut 137 cm
- výška řezu | height of cut 30 cm
- krytí | protection IP44
- úhel řezu | angle of cut 0° - 90°

· vybavení: stojan, nožní spínač, držák na lešení, 2x Ni-Cr řezací drát, čistící mosazný kartáč, nářadí a spojovací materiál, plastový box s kolečky
· equipment: stand, footswitch, holder, Ni-Cr cutting wire, cleaning brass brush, tools, hardware, plastic box with wheel



Č.p. | No. Specifikace | Specification

35348



1

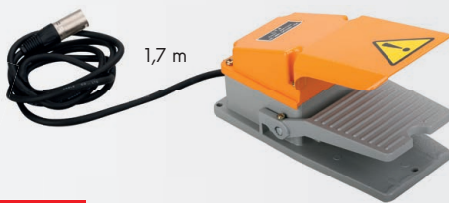

FESTA

NOŽNÍ SPÍNAČ
PRO ŘEZAČKU POLYSTYRENU
FOOTSWITCH

FOR A POLYSTYRENE CUTTER
pro | for 35330, 35345, 35348



Č.p. | No. Specifikace | Specification

35334

1



FESTA

STOJAN
PRO ŘEZAČKU POLYSTYRENU
STAND

FOR A POLYSTYRENE CUTTER
pro | for 35330, 35345, 35348



Č.p. | No. Specifikace | Specification

35336

1



FESTA

NÁHRADNÍ PRUŽINA
PRO ŘEZAČKU POLYSTYRENU
REPLACEMENT SPRING

FOR A POLYSTYRENE CUTTER
pro | for 35330, 35345, 35348



Č.p. | No. Specifikace | Specification

35332

1



FESTA

DRŽÁK NA LEŠENÍ
PRO ŘEZAČKU POLYSTYRENU
SCAFFOLD HOLDER

FOR A POLYSTYRENE CUTTER
pro | for 35330, 35345, 35348



Č.p. | No. Specifikace | Specification

35333

1



FESTA

**ŘEZAČKA
VINYLU A LAMINÁTU
LAMINATE FLOOR CUTTER**

max. 10 mm



Č.p. | No. Specifikace | Specification
36140 210 mm

4



**HLADÍTKO PLASTOVÉ
TROWEL PLASTIC**

MADE IN EU



Č.p. | No. Specifikace | Specification
34028 400 x 180 mm

20



**ŠKRABÁK NA STARÉ OMÍTKY
BAR TROWEL**

MADE IN EU



Č.p. | No. Specifikace | Specification
32311 400 x 180 mm

2



**ŠKRABÁK NA YTONG - HRUBÝ ZUB
YTONG SCRAPER**

MADE IN EU



Č.p. | No. Specifikace | Specification
32332 450 x 95 mm

2



**ŠKRABÁK NA BŘÍZOLIT
BRYOZOLITE SCRAPER**

MADE IN EU



Č.p. | No. Specifikace | Specification
32333 230 x 145 mm

2



FESTA

**DRŽÁK ŠPACHTLE
PRO CELOPLOŠNÉ TMELĚNÍ**
STAINLESS STEEL PUTTY KNIFE HOLDER

- pro | for 31555 - 31559
- násada | handle 52010, 52011, 52012, 52020, 52030



Č.p. | No. Specifikace | Specification

31610

1



VÁLEČEK NA NANÁŠENÍ STĚRKY
SKIM COAT ROLLER

- ručka | handle 180 mm - 52630
- ručka | handle 250 mm - 52625
- násada | handle 52010, 52011, 52012, 52020, 52030

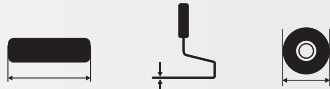

Č.p. | No. Specifikace | Specification

52611	250 mm	Ø 8 mm	Ø 48 mm	50
52612	180 mm	Ø 8 mm	Ø 48 mm	10

1

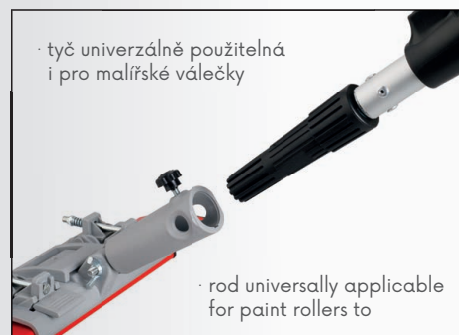
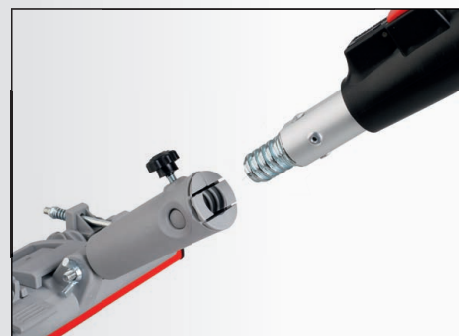

· tyč univerzálně použitelná
i pro malířské válečky

· rod universally applicable
for paint rollers to



FESTA

NÁSADA TELESKOPICKÁ
TELESCOPIC HANDLE

- závit pro | thread for 31610, 34203



Č.p. | No. Specifikace | Specification

52011	88 - 140 cm
-------	-------------

1



- 3 polohy přepínání zpětného odskoku
- 3 position reverse step switch



- otočná hlava o 360°
- 360° rotatable head

- nárazuvzdorná rukojeť nylon + sklovlákno
- impact - resistant handle nylon + fiberglass



- přepínání dávkování
- adjustable thrust ratio 9:1 / 18:1



FESTA

PISTOLE VYTLAČOVACÍ
S PŘEPÍNAČEM ZPĚTNÉHO ODSKOKU
A DÁVKOVÁNÍ
CAULKING GUN
WITH REVERSE STEP SWITCH
AND ADJUSTABLE THRUST RATIO

Č.p. / No. Specifikace / Specification

38027



1



zapnutý odskok
dripless

vypnutý odskok
no dripless

- přepínač zpětného odskoku
- back step switch

FESTA

PISTOLE VYTLAČOVACÍ
S PŘEPÍNAČEM ZPĚTNÉHO ODSKOKU
CAULKING GUN
WITH REVERSE STEP SWITCH

Č.p. / No. Specifikace / Specification

38028



02/2023



1



**NIVELAČNÍ KLIP
SADA**
LEVELING CLIP - SET

50x

Č.p. | No. Specifikace | Specification
37199 1,5 mm



NIVELYS
LEVELING SYSTEM **FESTA**

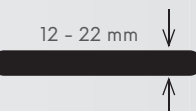

SPONY DISTANČNÍ
LEVELING CLIP

100x

Č.p. | No. Specifikace | Specification
37162 1,5 mm



FESTA

**PŘISAVKA NA DLAŽBU
S INDIKÁTOREM TLAKU**

HOLDER TILE
WITH PRESSURE INDICATOR
pro hrubé povrchy | for rough surfaces

Č.p. | No. Specifikace | Specification
36325 max. nosnost | max. load 220 kg

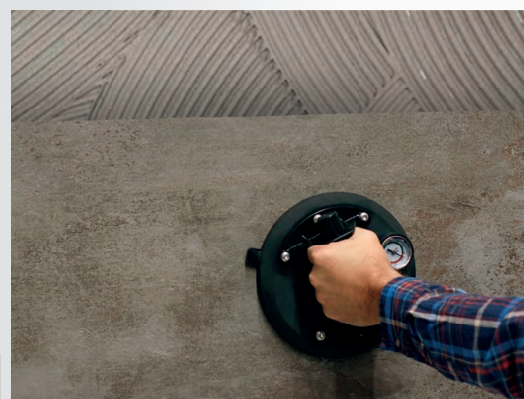
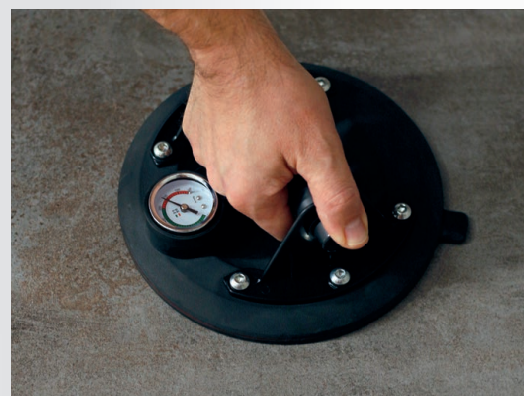



DVEŘNÍ ZÁVĚS PROTI HMYZU
MAGNETICKÝ, ANTRACIT
MAGNETIC DOOR SCREEN



Č.p. No.	Specifikace Specification
40077	100 x 220 mm

1



FESTA

POPRUH UPÍNACÍ
RATCHET STRAP



02/2023



Č.p. No.	šířka	délka	nosnost	ks
51032	25 mm	5 m	500 kg	1

6

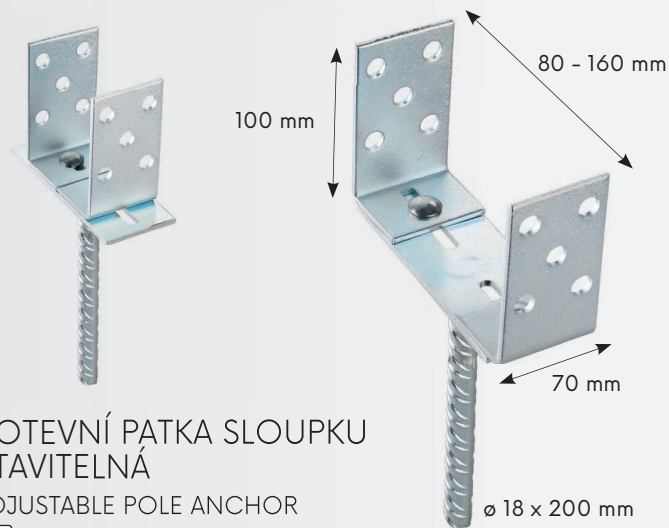

KOTEVNÍ PÁTKA SLOUPKU
STAVITELNÁ
ADJUSTABLE POLE ANCHOR

Zn



Č.p. No.	Specifikace Specification	tl.
55465	80 - 160 x 70 mm	100 mm

4 mm

1

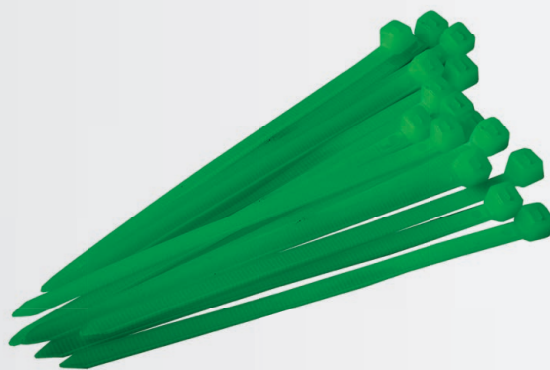

PÁSKY VÁZACÍ ZELENÉ
BINDING TAPES - GREEN

· EN 50146
· nylon



50x

Č.p. No.	Specifikace Specification
23875	120 mm

4,8 mm

1



KLÍČ ODVZDUŠŇOVACÍ
PRO TOPNÁ TĚLA SE ZÁSOBNÍKEM
RADIATOR BLEED KEY WITH WATER TANK



Č.p. No.	Specifikace Specification
17459	50 ml

1

GRAFICKÉ SYMBOLY POUŽITÉ V KATALOGU | GRAPHIC SYMBOLS USED IN CATALOG

PIKTOGRAMY SPECIFIKACE PRODUKTŮ PRODUCT SPECIFICATIONS USED ICONS



SPECIFIKACE POUŽITÍ · APPLICATION SPECIFICATIONS ·

- dřevo · wood ·
- keramika · ceramics ·
- plasty · plastic ·
- hliník · aluminium ·
- měď · copper ·
- kámen · stone ·
- sklo · glass ·
- zdivo · wall ·
- papír · paper ·
- ocel · steel ·
- kompozit · composite ·
- obklady · tiles ·
- nerezová ocel · stainless steel ·
- omítka · plaster ·
- dřevo se šrouby, hřebíky · wood with screw, nails ·
- sádkarton · drywall ·
- pro vrtání do materiálů s pevností v tahu do ...
for drilling in materials with tensile strength up to ... ·

- S2** · funkční části z vysoce legované nástrojové oceli S2
· functional parts made of high-alloy tool steels S2
- HSS** · funkční části vyrobeny z rychlořezné oceli
· functional parts made of high-speed steel
- Cr-Mo** · funkční části z chrom-molybdenové oceli
· functional parts from chrome-molybdenum steel
- CrV** · funkční části z chrom-vanadové oceli
· functional parts from chrome-vanadium steel
- INOX** · funkční části z nerezavějící oceli
· functional parts from stainless steel
- NYLON** · nylonová rukojeť
· nylon handle
- TEFLON** · teflonový povrch
· teflon surface
- Zn** · zinkováno
· zinc coated surface
- TiN** · povrch potažen nitridem titanu
· titanium nitride coated surface
- HRC 58-61** · tvrdost materiálu funkčních částí podle Rockwella
· the hardness of the functional parts material (Rockwell)
- 40% PES** · složení materiálu - obsahuje 40% polyesteru
· material composition - contains 40% of polyester
- PES** · složení materiálu - vyrobeno z polyesteru
· material composition - made of polyester
- diamantová zrna na povrchu funkčních částí
· diamond grains on the surface of functional parts
- magnetické
· magnetic

- SDS+** · způsob uchycení
· mounting type
- SDS MAX** · způsob uchycení
· mounting type
- M14** · způsob uchycení
· mounting type
- 72T** · počet zubů ráčny
· number of ratchet teeth
- 36T** · počet zubů ráčny
· number of ratchet teeth
- 1/2"** · velikost uchycení
· mounting size
- 3/4"** · velikost uchycení
· mounting size
- 1/4"** · velikost uchycení
· mounting size
- 27 dB** · údaj o výši ochrany sluchu
· information about hearing protection
- DIN 3113** · splňuje uvedenou normu
· complies with this standard
- IP 54** · splňuje uvedenou normu
· complies with this standard
- 32x** · počet produktů v sadě
· set contains this number of products
- II. class** · splňuje uvedenou třídu přesnosti
· complies with the specified accuracy class
- III. class** · splňuje uvedenou třídu přesnosti
· complies with the specified accuracy class
- vhodné do chladného počasí
· suitable for cold weather
- ERGO HANDLE** · ergonomická rukojeť
· ergonomic handle
- HOBBY** · pro hobby použití
· for hobby use
- 2x AAA** · počet a typ baterií
· number and type of batteries
- UV STABLE** · odolné proti UV záření
· UV stable
- RUBBER ENDS** · nárazuvzdorné gumové koncovky
· crashproof rubber ends

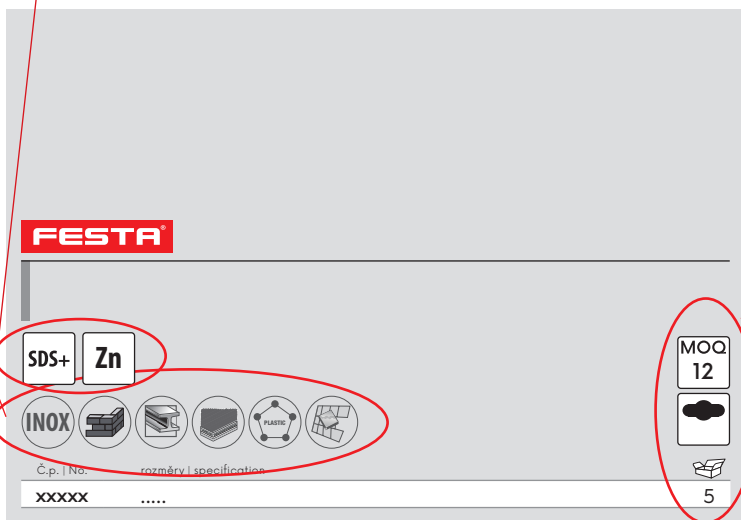

SPECIFIKACE BALENÍ, NASKLADNĚNÍ PACKAGING AND STOCK INFORMATION

- baleno v krabici
· packed in a box
- balení se závěsem
· packed with euroslot
- MOQ 12** · minimální objednatelné množství
· minimum order quantity
- počet kusů v balení
· no. of pieces in the package

SPECIFIKACE PRODUKTŮ VODNÍHO PROGRAMU · WATERING PRODUCTS SPECIFICATIONS ·

volitelný tvar proudu vody · adjustable spray patterns ·

minimální a maximální tlak · minimum and maximum pressure ·

maximální průtok vody · maximum water flow ·

zavlažovaná plocha · irrigated area ·

velikost závitů pro připojení adaptéru · adaptor thread size ·

průměr hadice pro připojení do rychlospojky · hose diameter for connector ·

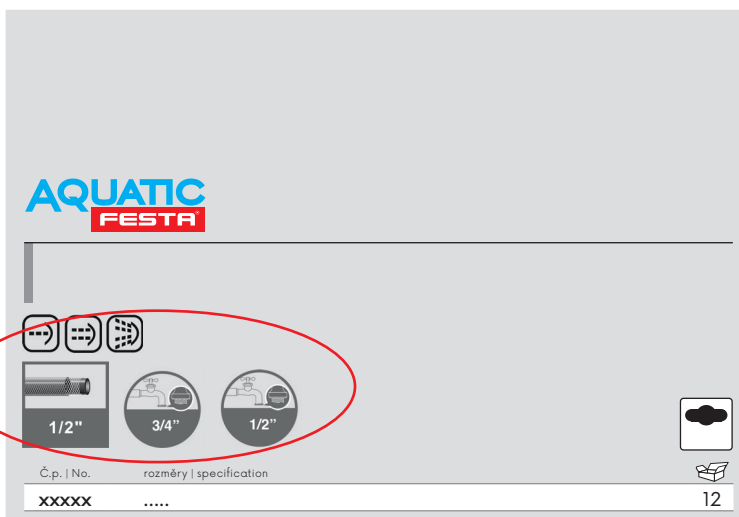

20
23



PROFESSIONAL  TOOLS



festatools



#festatools



festatools

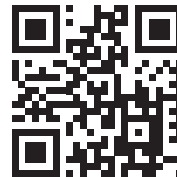

www.festa.tools